

### 温度检测

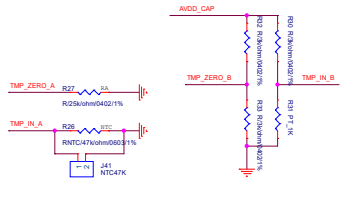

### GPS\_ANT

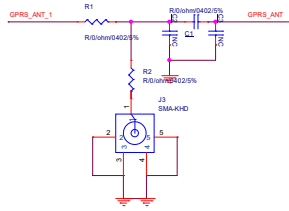

### GPS\_ANT

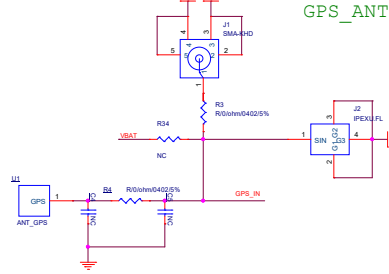

### MAKE点



### 测试点



### AUDIO

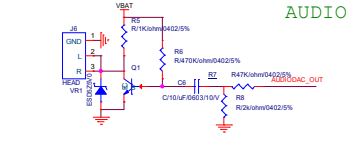

### 充电

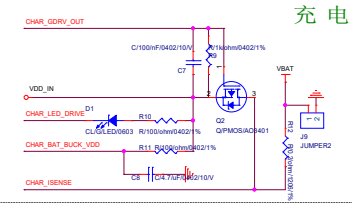

### 电源 3.6V-4.2v drive >1A

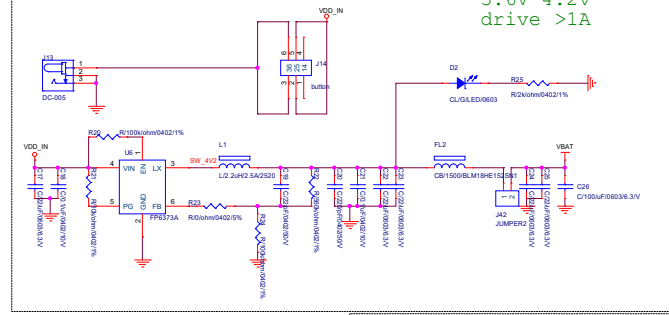

### SPI 串口

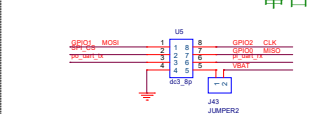

### 复位

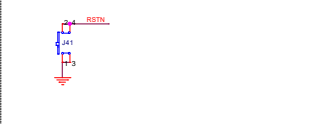

### MIC

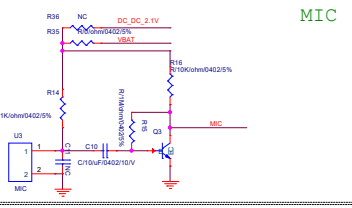

### SIM

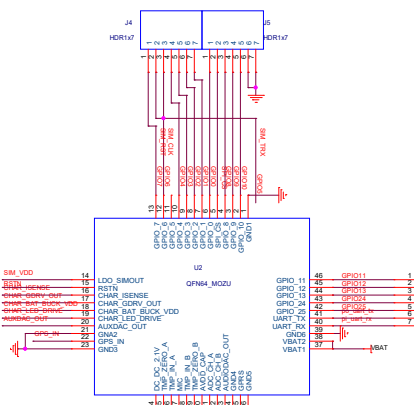
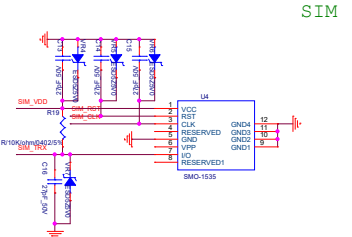

Prepared by: jk yang  
 Issued Date: 2026/03/23  
 File: S\_M Board  

Rev	Doc	Number	Module	Rev
C				

 Date: Monday, April 13, 2021 Sheet: 3 of 4